

telergon
gorlan

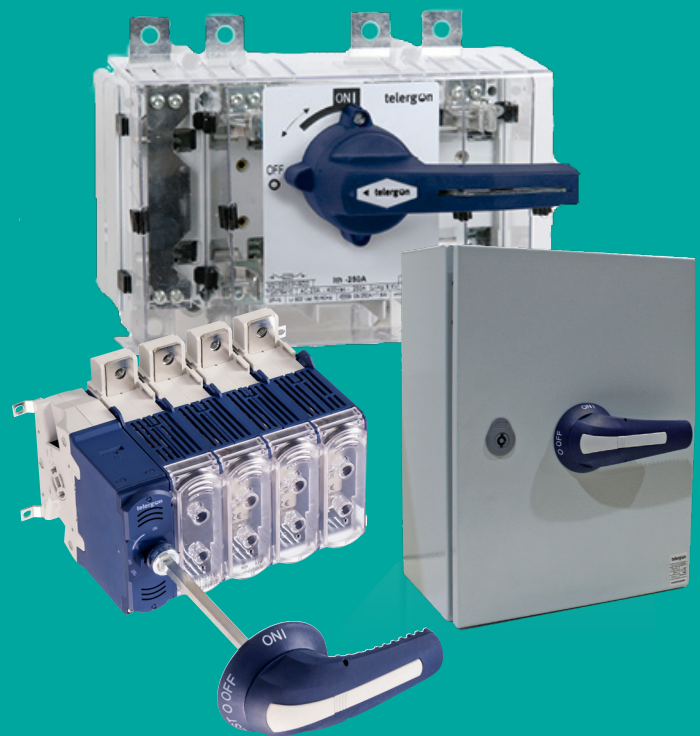

SERIES M3 & M21
Interruptores seccionadores
con fusibles



www.telergon.com



gorlan

Interruptores seccionadores con fusibles

¿Qué es un interruptor seccionador con fusibles?

Se trata de una combinación de un interruptor para abrir y cerrar el circuito, y fusibles para proteger el mismo en caso de sobrecargas y cortocircuitos.



SERIE M3
32A-250A
Soluciones compactas

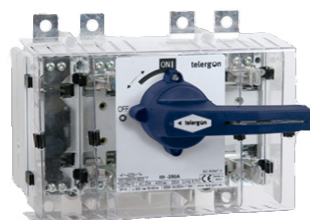

SERIE M21
400A-800A



SERIE CIF
Soluciones en caja
(metal y poliéster)



Aplicaciones de corte en carga. Contactos de doble ruptura.



Tapas y cubrebornes para la protección de terminales.



Posición TEST disponible hasta 250 A.



Mando panel bloqueable con candado en OFF.



Versiones con neutro fijo.



Capacidad de cortocircuito hasta 200kA.



Conexión de brida hasta 100A y por terminal hasta 800A.



Accionamiento frontal o lateral (solo en M3). Instalación sencilla.



Disponible para fusibles NFC, DIN, BS y Clase J.



Mandos IP65 / NEMA 4X.

► APLICACIONES

Cuadros temporales de obra



Fotovoltaica (SSAA)



HVAC



Cuadros de distribución



Centros de control de motores



Recintos feriales

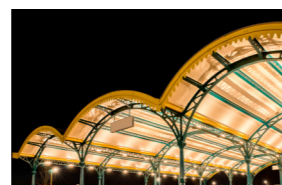

Electrónica de potencia



Variadores de frecuencia

Arrancadores

UPS

SERIES M3

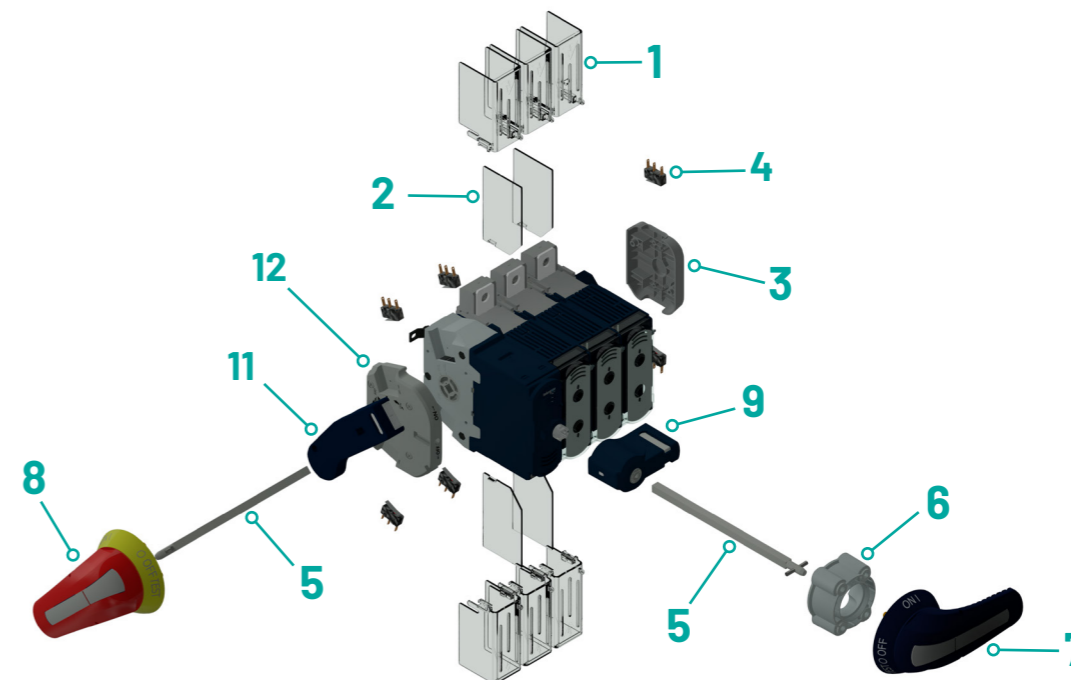

SERIES M21

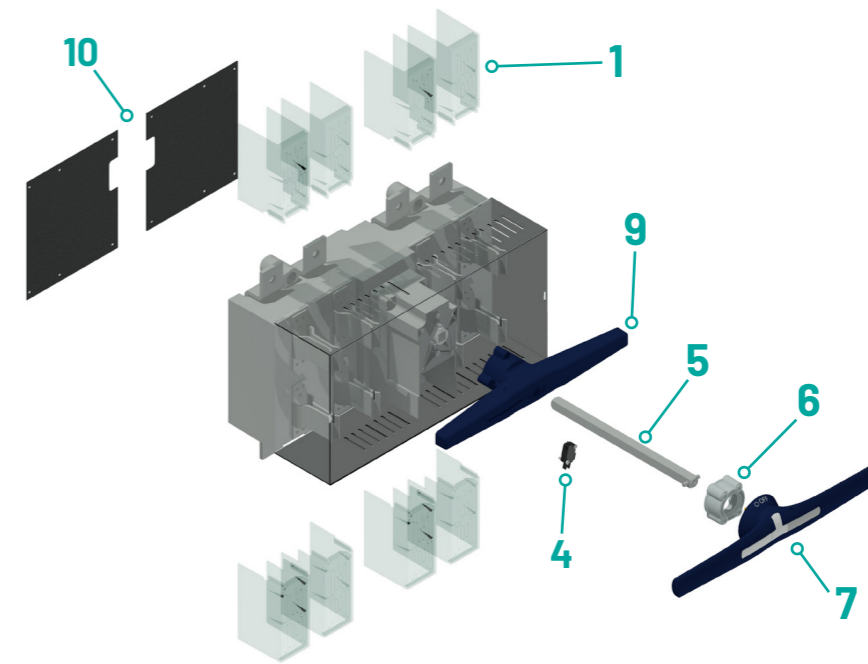

- | | | |
|--------------------------------------|------------------------------|---------------------------------------|
| 1 Cubrebornes | 5 Eje prolongado | 9 Mando directo |
| 2 Separador de fase | 6 Centrador de eje | 10 Placa de protección trasera |
| 3 Carcasa contacto simultáneo | 7 Mando panel | 11 Mando directo lateral |
| 4 Contacto auxiliar | 8 Mando panel lateral | 12 Carcasa contacto adelantado |

► SERIE M3 | 2P, 3P, 3P+N & 3P+ND | 32A-250A



Amp.	Fusible	Calibre	Conexión	2P	3P	3P+N ^(*)	3P+ND (neutro fijo desconectable)	Accionamiento frontal				
								Mando directo	Mando panel (eje incluido)		ON-OFF Código	ON-OFF-TEST Código
									Estándar	Emergencia		
Código	Código	Código	Código	Código	L (mm)	Código	Código					
32	BS-A1-A2	00	00	M3-00322PBB10	M3-00323PBB10	M3-00323NBB10	M3-00323DBB10	DM3SIB1	177	DM3SAB2	DM3SAB1	
50	14x51			M3-00502PBC20	M3-00503PBC20	M3-00503NBC20	M3-00503DBC20					
63	BS-A2-A3			M3-00632PBB20	M3-00633PBB20	M3-00633NBB20	M3-00633DBB20					
63	NH000			M3-00632PBD20	M3-00633PBD20	M3-00633NBD20	M3-00633DBD20					
80	BS-A3	00	00	M3-00802PBB30	M3-00803PBB30	M3-00803NBB30	M3-00803DBB30	DM3SIB1	177	DM3SRB2	DM3SRB1	
100	22x58			M3-01002PBC30	M3-01003PBC30	M3-01003NBC30	M3-01003DBC30					
100	NH000	00	00	M3-01002PBD30	M3-01003PBD30	M3-01003NBD30	M3-01003DBD30	DM3SIB1	177	DM3SAB2	DM3SAB1	
100	BS-A3			M3-01002PTB30	M3-01003PTB30	M3-01003NTB30	M3-01003DTB30					
125	BS-A3	0	0	M3-01252PTB30	M3-01253PTB30	M3-01253NTB30	M3-01253DTB30	DM3SIB1	177	DM3SRB2	DM3SRB1	
125	22x58			M3-01252PTC30	M3-01253PTC30	M3-01253NTC30	M3-01253DTC30					
125	NH00			M3-01252PTD40	M3-01253PTD40	M3-01253NTD40	M3-01253DTD40					
160	NH00	0	0	M3-01602PTD40	M3-01603PTD40	M3-01603NTD40	M3-01603DTD40	DM3SIB1	177	DM3SAB2	DM3SAB1	
160	BS-A4			M3-01602PSB50	M3-01603PSB50	M3-01603NSB50	M3-01603DSB50					
200	BS-B1-B2	1	1	M3-02002PSB60	M3-02003PSB60	M3-02003NSB60	M3-02003DSB60	DM3SI11	227	DM3SA12	DM3SA11	
200	NH1			M3-02502PSD50	M3-02503PSD50	M3-02503NSD50	M3-02503DSD50					
250	BS-B3			M3-02502PSB80	M3-02503PSB80	M3-02503NSB80	M3-02503DSB80					

► SERIE M21 | 3P, 3P+N & 3P+NF | 400A-800A

Amp.	Fusible	Calibre	Conexión	3P	3P+N ^(*)	3P+NF (neutro fijo)	Accionamiento frontal	
							Mando directo	Mando panel (eje guía incluido)
							Código	Código
400	NH2	2	00	M2104003PSD20	M2104003NSD20	M2104003FSD20	DM2SI21	DS-LA22
400	BSB1...BSB4			M2104003PSB50	M2104003NSB50	M2104003FSB50		DS-LR22
630	NH3	3	00	M2106303PSD30	M2106303NSD30	M2106303FSD30	DM2SI31	DS-LA31
800	NH3			M2108003PSD30	M2108003NSD30	M2108003FSD30		DS-LR31
630	BSC1...BSC2			M2106303PSB70	M2106303NSB70	M2106303FSB70		
800	BSC1...BSC3			M2108003PSB80	M2108003NSB80	M2108003FSB80		

^(*) Con neutro avanzado en el cierre y retardado en la apertura. Bajo demanda también disponibles en 4P.

⁽²⁾ Con el código de mando lateral, la carcasa del contacto auxiliar está incluida (DM3AMB1/DM3AM11), ya que es necesaria para instalación.

⁽³⁾ Para ser empleados como contactos de señalización o control. Ie = 0.1A a 125 VAC y 0.1A a 30 VDC (cargas resistivas) (M3). Este código incluye únicamente una pieza de micro auxiliar (1 pieza por bolsa), por lo que es necesario pedir tantas unidades como micros de cualquier tipo se necesiten.

⁽⁴⁾ Un juego para entrada o salida indistintamente.



Calibre	Accionamiento lateral				Contactos auxiliares ^(*) (1 unidad)	Carcasa de contactos auxiliares ⁽⁷⁾		Ejes prolongados	Separadores de fase	Cubrebornes ⁽⁴⁾	Centrador de eje		
	Mando directo ⁽²⁾	Estándar	Emergencia	Mando panel (eje incluido)		Adelantados	Simultáneos						
												Código	L (mm)
00	DM3SSB1	177	DM3SBB2	DM3SBB1	DM3AUB1	DM3AMB1	DM3ASB1	250	DM3EP01	-	-	-	DS-EC00
0	DM3SSB1	177	DM3SBB2	DM3SBB1	DM3AUB1	DM3AMB1	DM3ASB1	250	DM3EP01	2P	DM3SF01 ⁽⁶⁾	DM3CU01	DS-EC00
								387	DM3EP02	3P	DM3SF02 ⁽⁶⁾	DM3CU02	
1	DM3SS11	227	DM3SEB2	DM3SEB1	DM3AUB1	DM3AM11	DM3AS11	387	DM3EP02	3P+N	DM3SF03 ⁽⁶⁾	DM3CU03	
								375	DM3EP11	2P	DM3SF11	DM3CU11	
536	DM3EP12	3P+N	DM3SF13	DM3CU13									
										ND	-	DM3CU14 ⁽⁸⁾	

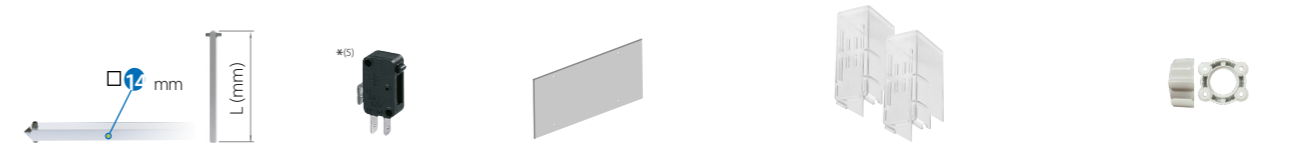

Calibre	Ejes prolongados			Contactos auxiliares ⁽⁵⁾		Placa protectora trasera	Cubrebornes ⁽⁴⁾			Centrador de eje
	□	L (mm)	Código	1NO+1NC Código	2NO+2NC Código		3P entrada Código	3P salida Código	3P+N entrada / salida Código	
2	14	345	DS-EP23	D5LAU01	D5LAU02	3P DM2PP21	DM2CU21	DM2CU22	DM2CU23	DS-EC00
3	14	345	DS-EP23	D5LAU01	D5LAU02	3P DM2PP31	DM2CU31	DM2CU32	DM2CU33	DS-EC00
						3P+N DM2PP32				

⁽⁵⁾ Para ser empleados como contactos de señalización o control. - Ie = 16A (cargas resistivas) 4A (cargas inductivas) a 250 Vac. (M21)

⁽⁶⁾ En tamaño 22x58 y BS el código del aparato incluye los separadores de fase instalados

⁽⁷⁾ Con el propio interruptor, se pueden instalar un contacto adelantado 1NO+1NC (posición ON-OFF) y otro 1NO+1NL (posición TEST). Capacidad máxima con carcasa: 3NO+3NC para posición OFF (2 contactos adelantados y 1 simultáneo) 2NO+2NC para posición TEST (2 contactos adelantados)

⁽⁸⁾ Este código incluye únicamente el cubrebornes para el polo neutro desconectable, es necesario pedir también el código para 3P cubrebornes: DM3CU02 o DM3CU12.

INFORMACIÓN TÉCNICA



IEC-EN-UNE 60947-1 IEC-EN-UNE 60947-3			00					0		1		2		3			
			32 A	50 A	63 A	80 A	100 A	100 A	125 A	160 A	160 A	200 A	250 A	400 A	630 A	800 A	
Tipo de fusible			BS-A1-A2	NFC 14x51	NH000 BS-A2-A3	BS-A3	NH000 NFC 22x58	BS A3	NH00 BS-A3 NFC 22x58	NH00	BS-A4	B S-B1-B2	NH1 BS-B3	NH2 BSB4	NH3 BS-C1...BSC2	NH3 BS-C1...BSC3	
Características eléctricas	Intensidad térmica en ambiente a 35°C (y temporalmente 40 °C) ⁽¹⁾	I _{th}	A	32	50	63	80	100	100	125	160	160	200	250	400	630	800
	Tensión de aislamiento	U _i	Vac	1.000				1.000	1.000	1.000			1.000	1.000	1.000		
	Tensión de impulso	U _{imp}	kV	8				8	8	12			12	12	12		
	Intensidad de empleo en AC ⁽²⁾ (Frecuencia de empleo 50 / 60 Hz)	Ue 415 V AC21A	A	32	50	63	80	100	100	125	160	160	200	250	400	630	800
		Ue 415 V AC22A	A	32	50	63	80	100	100	125	160	160	200	250	400	630	800
	Potencia disipada en fusible ⁽³⁾	Ue 415 V AC23A/ AC23B	A	32	50	63	80	80	100	125	160*	160	200	250	400	630	630
		NH/DIN	W	-	-	5,8	-	6,6	-	9	11,2	-	-	17	30	48	57
Poder de corte	BS	W	2,9	-	5,6	6,5	-	8,5	11,3	-	14	14	18	29	44	63	
	NFC	W	-	4,8	-	-	9	-	11,4	-	-	-	-	-	-	-	
Comportamiento ante cortocircuitos	400 V; cos φ = 0,35÷0,45	A	256	400	504	640	640	800	1.000	1.280	1.280	1.600	2.000	3.200	5.040	5.040	
	400 V; cos φ = 0,45	A	320	500	630	800	800	1.000	1.250	1.600	1.600	2.000	2.500	4.000	6.300	6.300	
Corriente asignada de cortocircuito condicional ⁽⁴⁾	NH/DIN/NFC	kA rms	-	100	100	-	100	-	100	100	-	-	100	100	100	100	
	BS	kA rms	80	-	80	80	-	80	80	-	80	80	80	100	100	100	
Datos mecánicos	Corriente máxima de corte	kA (pico)	4,2	9,5	10,5	14	14	16,5	16,5	19,5	29	29	32	43	60,8	60,8	
	Durabilidad, número de maniobras ⁽⁵⁾	Ciclos	10.000				8.000		8.000		5.000		3.000				
Peso máximo	2P	kg	0,6	0,6	0,6	0,7	0,7	1	1	2,6							
	3P	kg	0,85	0,85	0,85	1	1	1,3	1,3	3,4	6,6	13	13				
	3P+N	kg	1,1	1,1	1,1	1,3	1,3	1,6	1,6	4,2	8	15	15				

*Categoría de operación B.

⁽¹⁾ De acuerdo a IEC 60947-1, sección 7.1.1. Temperatura ambiente mínima de -5°C.

⁽²⁾ Otros voltajes y/o categorías de utilización. Por favor, consultar.

⁽³⁾ Valores de potencia disipada de los fusibles en los ensayos. Por favor, consulte para fusibles con potencias disipadas superiores.

⁽⁴⁾ Con dispositivo que limite la intensidad de pico y la energía disipada a los valores indicados.

⁽⁵⁾ Según normativa, para otros valores consultar.

CAPACIDAD DE CONEXIÓN

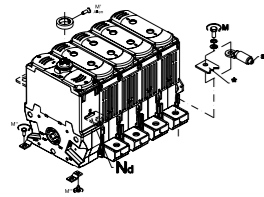
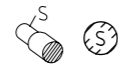

Calibre	I _{th}	S min. (Cu)		S max. (Cu)		H max (Cu)		L max (Cu)		T	M		
		mm ²	AWG	mm ²	AWG	mm	In	mm	in		Nxm	lbf/in	
M3	00	32A	6	10	1x25	1x4	-	-	-	-	2	17,7	
		50A	10	8									
		63A	16	6									
		80A	25	4									
		100A	35	3	50	1							
M3	0	100A	35	3	70	00	3	1/8	25	1	M8	6	53
		125A	50	1									
		160A	70	00									
		160A	70	00									
		200A	95	000			185	350	7	5/32	30	1 3/16	M10
M21	3	250A	120	250 kmil	2x185	2x400	2x7	2 5/32	50	1 3/32	M10	24	212
		400A	240	500							240	500	6
M21	3	630A	2x185	2x400	2x185	2x400	2x7	2 5/32	50	1 3/32	M12	45	398
		800A	2x240	2x500	2x240	2x500					M8	13	115

DIMENSIONES (mm)



M3
00

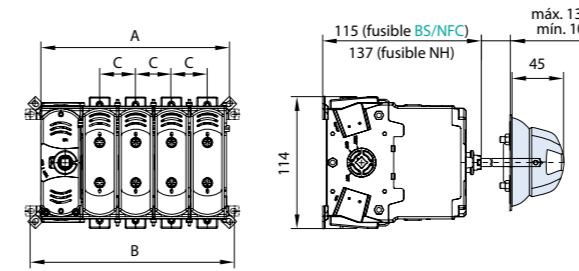

M3
0

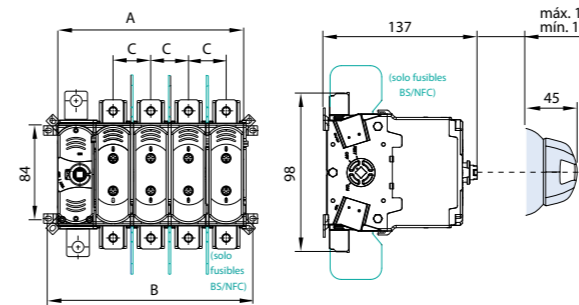

M3
1

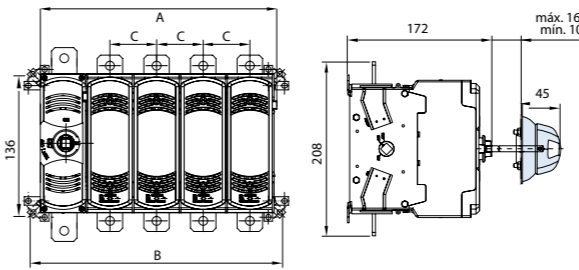

M21
2

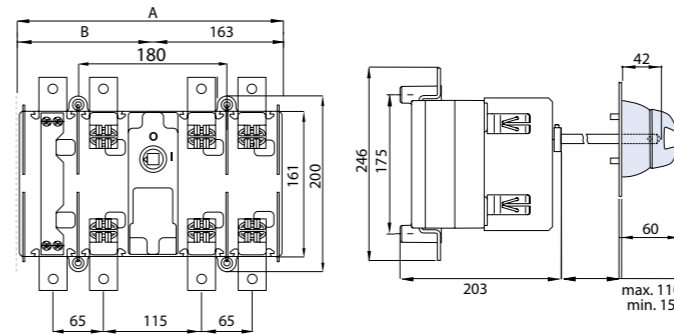

M21
3

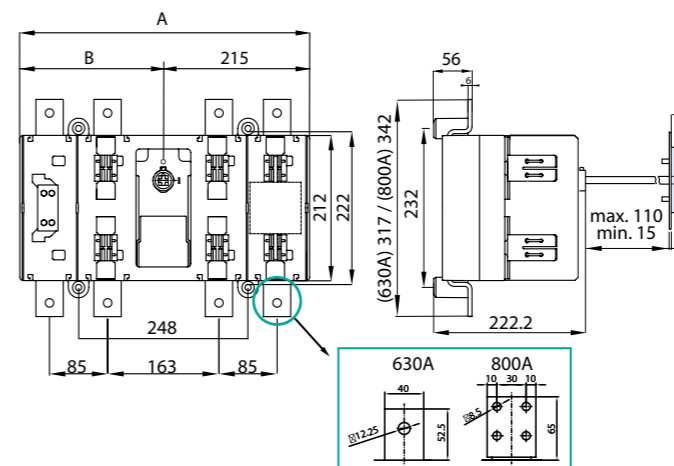

		A			B			C
		2P	3P	3P+N	2P	3P	3P+N	
NH BS NFC	32A	93	120	147	106	133	160	27
	50A							
	63A							
	80A 100A	101	132	163	114	145	176	31

		A			B			C
		2P	3P	3P+N	2P	3P	3P+N	
NH	125A 160A	109	144	179	123	158	193	35
	BS NFC	100A 125A 160A	110	146	182	124	160	196

		A			B			C
		2P	3P	3P+N	2P	3P	3P+N	
BS NH	160A 200A 250A	168	223	278	192	247	302	55

* Las dimensiones de 3P+ND son las mismas que para 3P

BS NH	400A	A		B	
		3P	3P+N	3P	3P+N
		274	329	111	166

BS NH	630A 800A	A		B	
		3P	3P+N	3P	3P+N
		381	426	166	211

* Las dimensiones de 3P+NF son las mismas que 3P+N

► SERIE M3 | 3P, 3P+N & 3P+ND | 30A-200A



UL	Amp.	Fusible	Calibre	Conexión	Accionamiento frontal			Accionamiento lateral				
					3P	3P+N ⁽¹⁾	3P+DN (neutro desmontable)	Mando directo	Mando externo (eje prolongado incluido)		Estándar	Emergencia
									Estándar	Emergencia		
					Código	Código	Código	Código	L	ON-OFF Code	ON-OFF TEST Code	
UL	30	J21x57	00	M3-00303PBJ300L	M3-00303NB300L	M3-00303DBJ300L	DM3SIB1	177 (mm)	DM3SAB2	DM3SAB1		
								6,96 (inch)	DM3SRB2	DM3SRB1		
	60	J27x60	0	M3-00603PTJ400L	M3-00603NTJ400L	M3-00603DTJ400L	DM3SIB1	177 (mm)	DM3SAB2	DM3SAB1		
								6,96 (inch)	DM3SRB2	DM3SRB1		
100	J29x117	1	M3-01003PSJ500L	M3-01003NSJ500L	M3-01003DSJ500L	DM3SI11	227 (mm)	DM3SA12	DM3SA11			
							8,93 (inch)	DM3SR12	DM3SR11			
	200	J41x146		M3-02003PSJ600L	M3-02003NSJ600L	M3-02003DSJ600L						

⁽¹⁾ Polo neutral adelantado y simultáneo.
⁽²⁾ Con el código de mando lateral, la carcasa del contacto auxiliar está incluida (DM3AMB1/DM3AM11), ya que es necesaria para instalación.
⁽³⁾ Para ser empleado como contacto de señalización o control. Ie = 0.1A a 125 VAC y 0.1A a 30 VDC (cargas resistivas) Este código incluye solo un contacto auxiliar (1 pc por paquete), así que si es necesario pedir tantas pcs como sean necesarias de cualquier tipo de contacto.

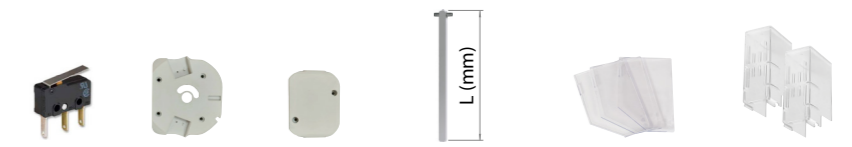

Tamaño	Accionamiento lateral ⁽²⁾				Contactos auxiliares ⁽³⁾ (1 unidad)	Carcasa contactos auxiliares		Ejes prolongados		Separadores de fase		Cubrebornes ⁽⁴⁾
	Mando directo	Mando panel (eje prolongado incluido)		Código		Código	Código	Código	Código	P	Código	
		Estándar	Emergencia									
	Código	L	ON-OFF Código	ON-OFF TEST Código		Código	Código	Código	L mm inch	Código		
00	DM3SSB1	177 (mm) 6,96 (inch)	DM3SBB2	DM3SBB1	DM3AUB1	DM3AMB1	DM3ASB1	250	DM3EP01	-	-	-
			DM3SEB2	DM3SEB1				387	DM3EP02	-	-	-
0	DM3SSB1	177 (mm) 6,96 (inch)	DM3SBB2	DM3SBB1	DM3AUB1	DM3AMB1	DM3ASB1	250	DM3EP01	3P	* ⁽⁵⁾	DM3CU020L
			DM3SEB2	DM3SEB1				387	DM3EP02	3P+N		DM3CU030L
1	DM3SS11	227 (mm) 8,93 (inch)	DM3SB12	DM3SB11	DM3AUB1	DM3AM11	DM3AS11	375	DM3EP11	3P	DM3SF12	DM3CU12
			DM3SE12	DM3SE11				536	DM3EP12	3P+N	DM3SF13	DM3CU13
							21,10		DN	-		DM3CU14 ⁽⁶⁾

⁽⁴⁾ Un juego para entrada o salida indistintamente.
⁽⁵⁾ En este tamaño el dispositivo (UL) incluye directamente los separadores de fase instalados.
⁽⁶⁾ Este código solo incluye los cubrebornes para el polo neutro desconectable, es necesario pedir también el código para 3P cubrebornes: DM3CU020L o DM3CU12.

► INFORMACIÓN TÉCNICA

UL98B		00	0	1			
		30 A	60 A	100 A	200 A		
Tipo de fusible		J 21x57	J 27x60	J 29x117	J 41x146		
Intensidad	Corriente térmica nominal	A	30	60	100	200	
	Intensidad de empleo	600Vac	A	30	60	100	200
	Tensión de funcionamiento máxima	Vac	600				
	Arranque directo trifásico	3 fases	240	Vac	7,5/22	15/42	30/80
480			Vac	15/21	30/40	60/77	100/124
		600	Vac	20/22	50/52	75/77	125/125
	Intensidad de cortocircuito a 600Vac	kA	200				
Resistencia mecánica	Número mínimo de operaciones mecánicas (ciclos)	10000		10000	8000		
	Número de operaciones eléctricas (ciclos)	6000					

► CAPACIDAD DE CONEXIÓN

Calibre	Ith	Cable rígido	Max conexión embarrado	Par de apriete
		Brida	Terminal	
		AWG	mm	lb-inch
00	30A	#10-2	-	17,7
0	60A	#6 %	20	53
1	100A	#3AWG-300kcmil	30	159
	200A	#3/0AWG-300kcmil	30	159

► DIMENSIONES

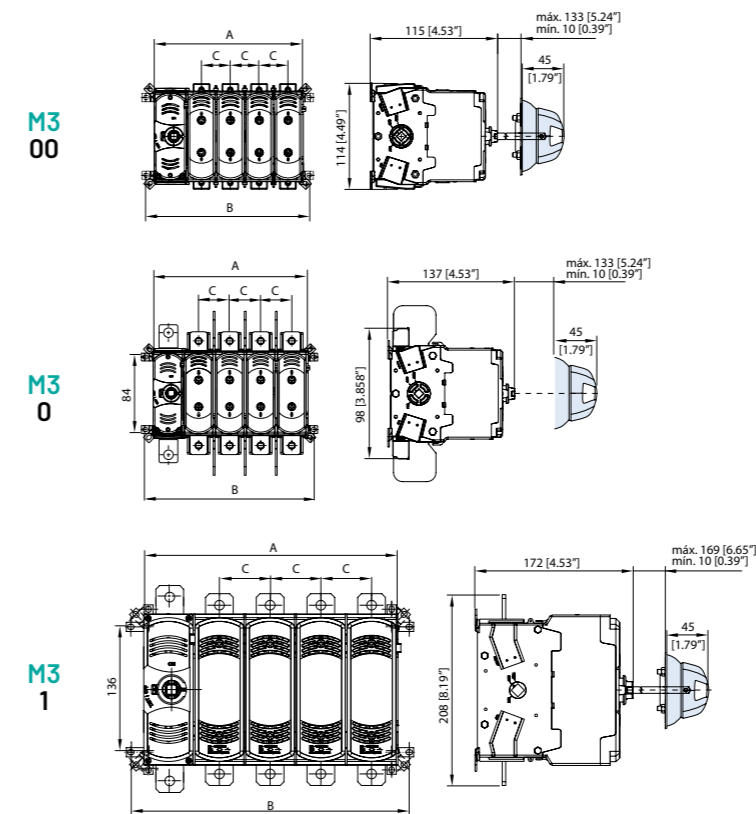

J	30A	mm	A		B		C
			3P	3P+N	3P	3P+N	
		mm	132	163	145	176	31
		inch	5.19"	6.41"	5.73"	6.95"	1.23"

J	60A	mm	A		B		C
			3P	3P+N	3P	3P+N	
		mm	146	182	160	196	36
		inch	5.74"	7.15"	6.31"	7.73"	1.42"

J	100A 200A	mm	A		B		C
			3P	3P+N	3P	3P+N	
		mm	223	278	247	302	55
		inch	8.81"	10.97"	9.72"	11.89"	2.57"

* Las dimensiones de 3P+ND son las mismas que 3P

► SERIE CIF | CAJA METÁLICA | 50 A - 800 A



CARACTERÍSTICAS GENERALES

- Fusibles DIN, NFC BS.
- Grado de protección IP65.
- Montaje en pared.
- RAL 7035.
- Versiones 3P y 3P+N.



Amp.	Fusible	Calibre	Conexión	Serie	3P	3P+N ^{*(1)}	Dimensiones de caja	Contactos auxiliares ^{*(2)} 1NO+1NC	Entrada de cable	Soportes de fijación	Cubrebornes ^{*(3)}		
					Código	Código					3p	3P+N	
												Código	Código
50	14x51	00	■	M3	CIF23C00503PBC2	CIF23C00503NBC2	300x300x200	DM3AUB1	125x215	20105079	-	-	
63	NH000		■	M3	CIF23C00633PBD2	CIF23C00633NBD2	300x300x200	DM3AUB1	125x215	20105079	-	-	
100	22x58		■	M3	CIF23C01003PBC3	CIF23C01003NBC3	300x300x200	DM3AUB1	125x215	20105079	-	-	
100	NH000		■	M3	CIF23C01003PBD3	CIF23C01003NBD3	300x300x200	DM3AUB1	125x215	20105079	-	-	
125	22x58	0	▸	M3	CIF23C01253PTC3	CIF23C01253NTC3	400x400x200	DM3AUB1	125x285	20105079	DM3CU02	DM3CU03	
125	NH00		▸	M3	CIF23C01253PTD4	CIF23C01253NTD4	400x400x200	DM3AUB1	125x285	20105079	DM3CU02	DM3CU03	
160	NH00		▸	M3	CIF23C01603PTD4	CIF23C01603NTD4	400x400x200	DM3AUB1	125x285	20105079	DM3CU02	DM3CU03	
250	NH1		▸	M3	CIF23C02503PSD5	CIF23C02503NSD5	600x400x250	D5LAU01	485x125	20105079	DM3CU12	DM2CU13	
400	NH2	2	▸	M21	CIF22C04003PSD2	CIF22C04003NSD2	800x600x260	D5LAU01	485x125	20105079	DM3CU22 ^{*(4)}	DM2CU23	
630	NH3		▸	M21	CIF22C06303PSD3	CIF22C06303NSD3	1000x600x260	D5LAU01	485x125	20105079	DM3CU32 ^{*(4)}	DM2CU33	
800	NH3		▸	M21	CIF22C08003PSD3	CIF22C08003NSD3	1000x600x260	D5LAU01	485x125	20105079	DM3CU32 ^{*(4)}	DM2CU33	

^{*(1)} Polo neutro adelantado y simultáneo. También disponible (M3) 4P y 3P+ND / (M21)- 4P y 3P+NF bajo pedido.

^{*(2)} Para ser empleados como contacto de señal o de control – Ie = 0.1A a 125 VAC y 0.1A a 30 VDC (cargas resistivas) (M3) / Ie = 16A (cargas resistivas) 4A (cargas inductivas) a 250 Vac (M21).

Al cerrar, cierra después de los contactos principales. Al abrir, se abre antes que los contactos principales.

^{*(3)} Un juego para entrada o salida indistintamente.

^{*(4)} Output

► SERIE CIF | CAJA POLIÉSTER | 50 A - 250 A



Amp.	Fusible	Calibre	Conexión	Serie	3P	3P+N ^{*(1)}	Dimensiones	Contactos auxiliares ^{*(2)} 1NO+1NC	Soportes de fijación	Cubrebornes ^{*(3)}			
					Código	Código				3P	3P+N		
												Código	Código
50	14x51	00	■	M3	CIF23P00503PBC2	CIF23P00503NBC2	400x300x200	DM3AUB1	20105085	-	-		
63	NH000		■	M3	CIF23P00633PBD2	CIF23P00633NBD2	400x300x200	DM3AUB1	20105085	-	-		
100	22x58		■	M3	CIF23P01003PBC3	CIF23P01003NBC3	400x300x200	DM3AUB1	20105085	-	-		
100	NH000		■	M3	CIF23P01003PBD3	CIF23P01003NBD3	400x300x200	DM3AUB1	20105085	-	-		
125	22x58	0	▸	M3	CIF23P01253PTC3	CIF23P01253NTC3	400x400x200	DM3AUB1	20105085	DM3CU02	DM3CU03		
125	NH00		▸	M3	CIF23P01253PTD4	CIF23P01253NTD4	400x400x200	DM3AUB1	20105085	DM3CU02	DM3CU03		
160	NH00		▸	M3	CIF23P01603PTD4	CIF23P01603NTD4	400x400x200	DM3AUB1	20105085	DM3CU02	DM3CU03		
250	NH1		▸	M3	CIF23P02503PSD5	CIF23P02503NSD5	600x400x230	DM3AUB1	20105085	DM3CU12	DM2CU13		



Telergon, SAU
Ctra. Castellón – Pol. La Cartuja
50720 La Cartuja Baja
Zaragoza, Spain



Tel. +34 976 500 876
info@telergon.com
www.telergon.com